



The wise choice for **U**ltra **R**eliable **B**earings

URB GROUP

**Bearings
for
Mining
Industry**



URB GROUP



320 Republicii Street,
731108 Barlad,
ROMANIA



phone: +40 235 / 411120, 412120
fax: +40 235 / 413838, 308200
www.urbgroup.com

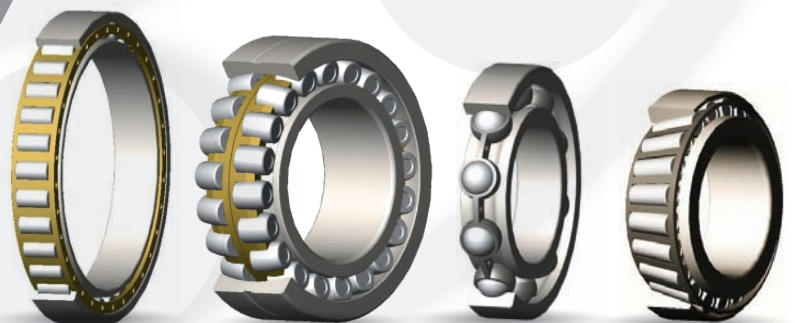

Bearings for the mining application must meet special requirements

- * **High operational reliability**
- * **Reduced maintenance requirements**
- * **High load carrying capacity**
- * **Simple mounting and dismantling**

In the mining sector severe operating and environmental conditions require extremely robust bearings. Bearings for mining industry it is used of bucket wheel excavators, draglines, conveyor belts, trucks, stackers, transport equipment and mine, loaders, long wall shearers, hoists.

Mining industry use many types of bearings: cylindrical rolling bearings, deep groove ball bearings, spherical roller bearings and tapered roller bearings.

Our range of services for the mining sector includes:





- * **Customer support in selection of bearings**
- * **Mounting and dismantling**
- * **Lubricant selection and consultancy**
- * **Calculation service with "Shaft Calculation"**
- * **Bearing inspection**
- * **Application-specific service packages for individual customer requirements**

PRODUCTS

Standard Bearings

In our catalogue "General Rolling Bearings v.14 2017" mainly ball bearings and roller bearings are listed.

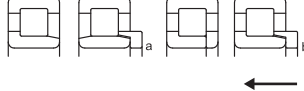
Standard Bearing types and their characteristics

| ● - excellent ◐ - poor ◑ - good ○ - unsuitable ◒ - fair ← - single direction ↔ - double direction | | PURELY RADIAL LOAD | PURELY AXIAL LOAD | COMBINED LOAD | MOMENT LOAD | QUIET RUNNING | HIGH SPEED | HIGH STIFFNESS | COMPENSATION OF MISALIGNMENT | LOW FRICTION | LOCATED BEARING | NON-LOCATED BEARING |
|---|---|--------------------|-------------------|---------------|-------------|---------------|------------|----------------|------------------------------|--------------|-----------------|---------------------|
| Deep groove ball bearings |  | ◑ | ◑ | ◑ | ◑ | ● | ● | ◑ | ● | ◑ | ◑ | |
| Cylindrical roller bearings - NU; N - NJ, NU+HJ, NUP, NJ+HJ |  | ● | ○ | ○ | ○ | ◑ | ● | ◑ | ◑ | ○ | ○ | |
| |  | ● | ◑ | ◑ | ○ | ◑ | ● | ◑ | ◑ | ◑ | ◑ | |
| Spherical roller bearings |  | ● | ◑ | ◑ | ○ | ◑ | ◑ | ● | ◑ | ◑ | ◑ | |
| Tapered roller bearings - single row |  | ● | ◑ | ● | ◑ | ◑ | ◑ | ◑ | ◑ | ◑ | ○ | |

DEEP GROOVE BALL BEARINGS

Series: 62; 63

Features

The deep groove bearings (design 2ZR and 2RSR) are sealed by dust shields and seals on both sides, and filled with grease for service life.



Applications:

- * Motors (Hydraulic Excavator)
- * Transmission (Wheel Loader)
- * Speed reducers (Wheel Loader)
- * Torque converter (Crawler Dozer)



CYLINDRICAL ROLLING BEARINGS

Series: 02; 03; 22; 23
Design: NU, NJ, NUP

Features

The E and EM series of high-load capacity, optimized profile on roller raceway, to optimize tension distribution. Can be manufactured with special internal design, to accommodate higher misalignment than standard.



Applications:

- * Cone Crusher
- * Wheel Loader (Transmission)
- * Hydraulic shovel (Pump, Speed Reducer)
- * Crawler Dozer (Transmission, Torque Converter)
- * Off-highway Truck (Differential)

SPHERICAL ROLLER BEARINGS

Series: 213, 222, 223, 230, 231, 232, 239, 240, 241

Features

Spherical roller bearings are utilized in every aspect of mining. They are critical to machine performance, and located in positions which are often difficult to access. URB uses the latest design practices to deliver bearings of optimal quality. We utilize heavy duty machined brass cages, optimized surface finishes and roller designs for smooth performance and long life.

The CA series are especially suitable for applications that operate under heavy or shock load condition.

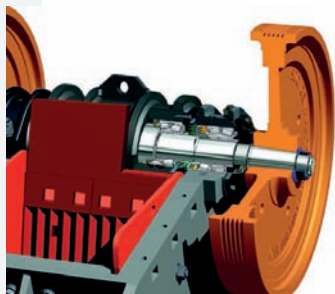
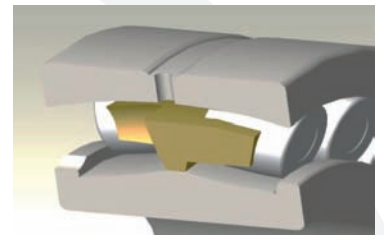

Applications:

- * Jaw Crusher
- * Vibrating Screen
- * Impact Crusher
- * Conveyor
- * Crawler Dozer (Transmission)

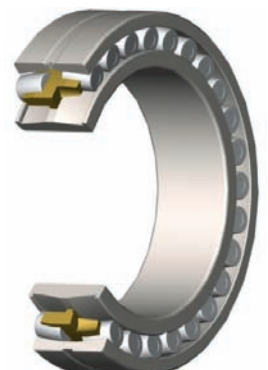

TAPERED ROLLER BEARINGS

Series: 30; 31; 32;

Features

Single row tapered roller bearings can accommodate combined load (radial + axial). This type of bearings is separable. The angle between the cup raceway and the bearing axis is the contact angle α . The larger the contact angle the greater the bearings axial load capacity. Cages are lightweight, made from pressed sheet steel and their construction allows using big diameter rollers.

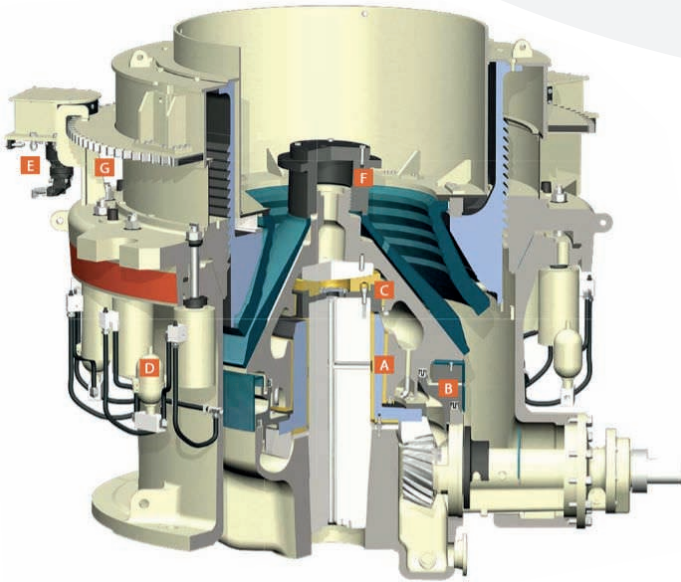

Applications:

- * Cone Crusher
- * Impact Crusher
- * Hydraulic Shovel (Motors)
- * Wheel loader (Front Axle, Transmission)
- * Electric Shovels
- * Haul Trucks

IMPROVEMENTS FOR STANDARD BEARINGS

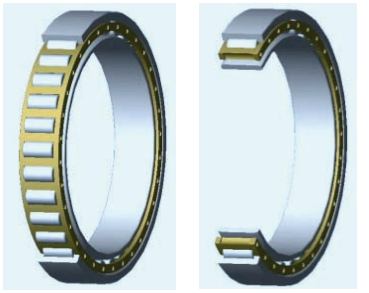
| Bearings Type | Improved design and process | Benefits |
|---|---|--|
|  <p>Deep Groove Ball Bearings</p> | <ul style="list-style-type: none"> * Premium raw material * Smaller roughness and roundness values * Optimized interior geometry | <ul style="list-style-type: none"> * Reduced friction in bearing * Reduce wear * Lowering operating temperature |
|  <p>Cylindrical Roller Bearings</p> | <ul style="list-style-type: none"> * Premium raw material * Optimized shoulders geometry * Crowing profile of inner ring raceway * Smaller roughness and roundness values * Superior surface finish of roller, logarithmic profile * Increased rollers number * Cage optimization to allow extra rollers * Simulation on specialized software | <ul style="list-style-type: none"> * Working temperature up to 150°C * Reduced friction in bearing * Capability to take greater axial load * Improved lubricant film formation * Reduced contact pressure * Increase of load ratings * Increase of life ratings |

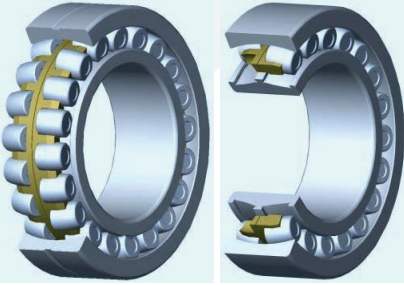
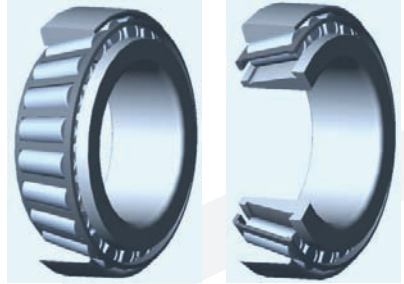
| Type Bearings | Improved design and process | Benefits |
|--|---|--|
|  <p data-bbox="137 546 408 577">Spherical Roller Bearings</p> | <ul style="list-style-type: none"> * High clean steel and heat treatment process * Optimized internal geometries * Improved manufacturing processes. (texture of surface in contact) * Reduce stress concentrations using finite element analysis (ANSYS) * Massive and rigid brass cage to accommodate high shocks and vibrations. * Optimized spherical profile of rollers | <ul style="list-style-type: none"> * Longer life and greater rigidity * Small values for residual austenite * Reduce wear * Increasing load carrying capability * Lowering operating temperatures * Optimum oil film between the contacting surfaces |
|  <p data-bbox="158 952 413 983">Tapered Roller Bearings</p> | <ul style="list-style-type: none"> * High clean steel and heat treatment process * Optimized internal geometry used Mesys simulation software * Low surface roughness of the rings and the rollers * Improved of geometry of the inner ring ribs and the roller end faces | <ul style="list-style-type: none"> * Lowering operating temperature Reduced friction in bearings * Optimized load distribution in the bearing |

SPECIAL BEARINGS

SEALED SPHERICAL ROLLER BEARINGS

These bearings are sealed with acrylonitrile rubber that assure special characteristics for wear to friction resistance to petroleum products and physical-mechanical properties and working temperature -50.....+150°C.

These bearings have greater width than standard bearings. Seals protect the bearings and lubricant from contaminants and increase bearing service life.

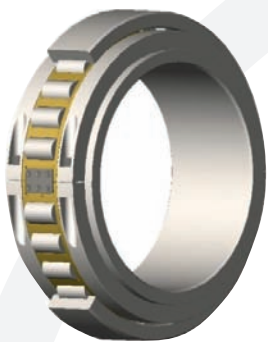
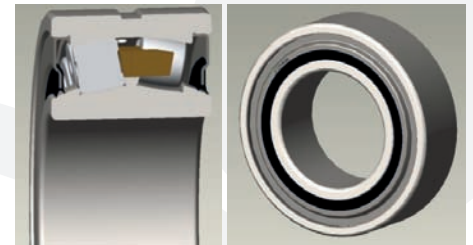

SPLIT CYLINDRICAL ROLLER BEARING

Design consists in split elements, caught together by fixing elements;
Cage type: Brass, roller guided;
They can replace sliding bearings.

BEARINGS DESIGNED FOR VIBRATING EQUIPMENT

MA – brass cage guided on outer ring
C4F80 – special clearance and tolerance for bore and outer ring.

W33 – Lubrication groove and holes

Optional:

K – tapered bore

S1...S4 – higher temperature running

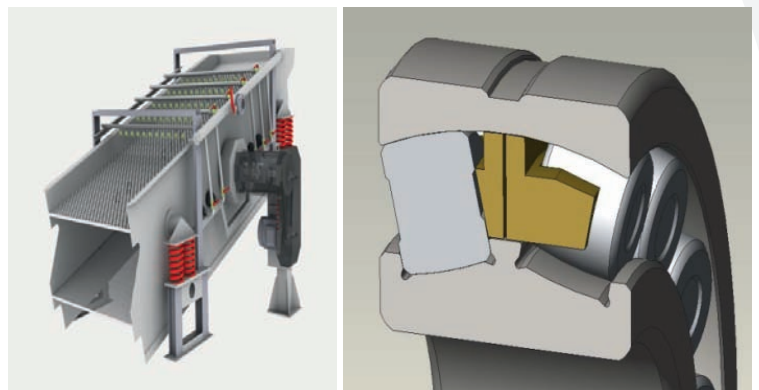

The company was set-up on May 1953 and it has a long tradition in manufacturing of bearings over 60 years, being one of the important bearing manufactures in the Central and South-East Europe.

The key to success has been a consistent emphasis on maintaining the highest quality of our products and services and investment in research and development.

We include the respect for clients and the satisfaction of their needs among our fundamental principles. Therefore we tried to respond better to the market requirements by offering, besides the bearings with standardized shapes and sizes, a large range of non-standardized bearings, specific to various applications.

